

Data Sheet



Article number: 0108077

Description: Retaining ring JK 62 DIN 984

Measures

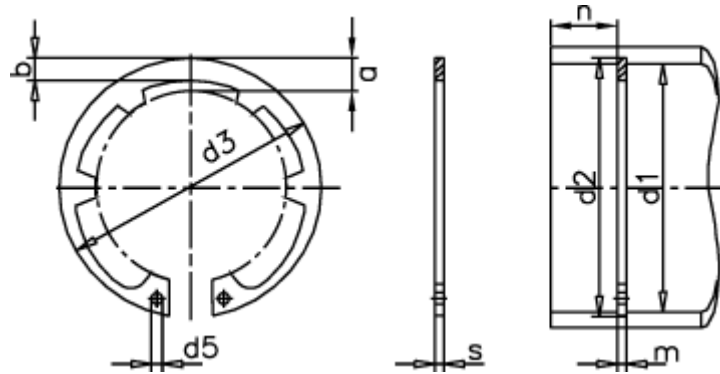

a max	= 8.2	FN kN	= 49.8	s	= 2.00
AN mm ²	= 299.0	FRg kN	= 13.0	t	= 1.50
b	= 5.6	FR kN	= 60.9	tol	= +0,30
d1	= 62	g	= 2.0	tol	= -0.07
d2	= 65.0	K kN-mm	= 112.0	tol	= +1,10-0,46
d3	= 66.2	m min	= 2.15	Tong	= ZGJ-3
d5 min	= 2.5	Nominal drive	= 4.5	Weight kg/1000	= 12.75
Description	= JK 62	Number of serrations	= 8		